

# User's Manual for Compact Tester **KT 3301 E**

Last update: 30 Sep. 2015

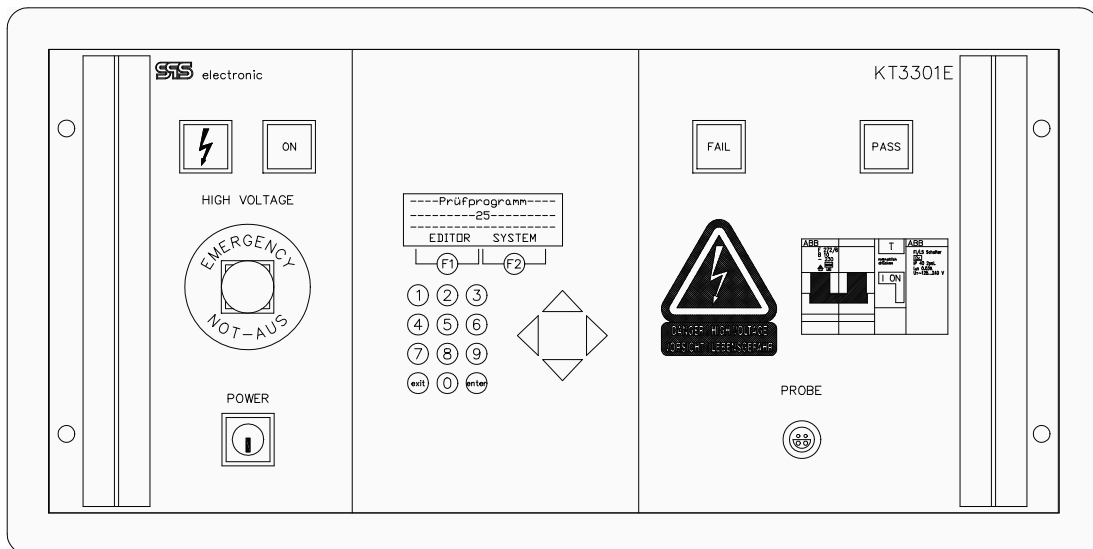

Series:	KT 3301 E
Serial number:	
Constructed in:	

*SPS electronic GmbH*  
Blätteräcker 18, 74523 Schwäbisch Hall

Phone: +49 (0) 79 07 878 - 0  
Fax: +49 (0) 79 07 878 - 10

e-mail: [info@spselectronic.com](mailto:info@spselectronic.com)  
Internet: [www.spselectronic.com](http://www.spselectronic.com)



## Contents

<b>1</b>	<b>General Information</b>	<b>5</b>
1.1	Information on this manual	5
1.2	Requirements for operation of device	7
1.3	Service	8
1.4	General instructions and regulations on safety	9
<b>2</b>	<b>Hardware Description</b>	<b>12</b>
2.1	Functions	12
2.2	Technical data	13
2.3	Design and functions	15
2.3.1	Front	15
2.3.2	Back	16
2.4	Expansions, options and accessories	17
<b>3</b>	<b>Operation</b>	<b>19</b>
3.1	Start of operation	19
3.1.1	Requirements	19
3.1.2	Installation of test station	19
3.1.3	Connecting DUT	20
3.2	Changing of program settings	21
3.2.1	Programming individual test programs	22
3.2.2	Changing of system parameters	22
3.2.3	Changing of test parameters	25
3.3	Executing tests	26
3.3.1	Continuity test	27
3.3.2	Protective wire test	28
3.3.3	Insulation test	30
3.3.4	High voltage test DC	32
3.3.5	High voltage test AC	34
3.3.6	Function test	36
3.4	Remote control via RS 232	38
3.4.1	Syntax	38
3.4.2	Global commands	39
3.4.3	Local commands	40
3.4.4	Status and error parameters	44
3.5	Error display	47
3.5.1	Error display	47
3.5.2	Error messages on LC display	47

3.6 Maintenance and function check ..... 48  
 3.6.1 Maintenance ..... 48  
 3.6.2 Function check..... 48

**Appendix ..... 49**

A Special functions ..... 49  
 B External Voltage Feed-In ..... 51  
 C Interface Configuration ..... 52  
 D Information on programming and program run ..... 57  
 E Protocolling of test results..... 58  
 F Handling of EEPROM Errors ..... 61  
 G Terms of warranty ..... 62

# 1 General Information

## 1.1 Information on this manual

This operating manual is part of the technical documentation for the compact tester *KT 3301E* of *SPS electronic GmbH*.

In this operating manual you will find all the information on how to operate this tester properly, safely and economically, how to prevent danger, how to reduce repair costs and downtimes as well as how to increase the tester's service life.

Should you, while reading this manual, find misprints, information you don't understand or wrong information, please don't hesitate to inform *SPS electronic GmbH* respectively.

### Contents

In this operating manual you will find three chapters and one appendix.

You will find additional information in the appendix.

The headline will show you which chapter you are reading.

The bottom line will show you the type of device in the middle and on the right-hand side the page number.

### Piktograms and symbols

- **Warnings** are symbolized by warning triangles with danger symbol, they warn of possible personal injury and/or damage to property.



**General Warning**



**Dangerous electric current or voltage**

- **Pointers** are symbolized by the information pictogram and give recommendations or additional information.



**You can order all of these accessories directly from *SPS electronic GmbH*.**

- **Continuations** of coherent sections on the next page are indicated by the symbol  in the lower right corner of a page.



**... PIKTOGRAMS AND SYMBOLS**

**More than one operation** is symbolized by ●

example: ● protective wire test (PE-test)  
● insulation test (IS-Test)

**Consecutive operations** are numbered step by step.

example: 1. switch on power switch  
2. press key F2 (< Prgrnr >)

**results** are symbolized by ⇒

example: ⇒ LC-display shows current program number.

## 1.2 Requirements for operation of device

### 1.2.1 Operating specifications

The tester must be reliable and perform properly.

Only authorized personnel, e.g. electricians and/or electrical engineers who have read and fully understood this manual, are allowed to operate a tester.

Operation of the tester is not allowed if:

- the tester is not assembled, operated, maintained and serviced according to this manual or as recommended by *SPS electronic GmbH* respectively
- it is modified and/or repaired without authorization
- it is disassembled and/or safety equipment is disregarded
- components, tools, auxiliary equipment and/or means, and/or fuel, coolants and lubricants which have not been approved or recommended by *SPS electronic GmbH* are being used
- replacement parts which are not original *SPS electronic GmbH* ones or which are not supplied by a supplier recommended by *SPS electronic GmbH* are being built in

### 1.2.2 Product liability

Series 3301 testers are manufactured, adjusted/calibrated and tested according to the latest and approved technical and safety regulations.

The testers comply in design and in the selection of component parts and accessories with the terms agreed upon in the order confirmation.

*SPS electronic GmbH* will be liable for errors or failures/ommissions to the extent of the obligations guaranteed in the order confirmation.

The terms of guarantee and liability of the *SPS electronic GmbH* sales and delivery conditions are applicable.

The contents of this operating manual complies with the condition of this tester at time of issue of this manual.

*SPS electronic GmbH* products are subject to change due to continuous development and improvement.

No liability claims can be made on the grounds of the contents of this manual (e.g. data, specifications, diagrams/charts, misprints, etc.).

Errors and omissions excepted!

***SPS electronic GmbH* will only be liable if the tester *KT 3301E* has been operated or used properly (pl. see 1.2.1).  
If the testers are not operated or used properly the operator will be solely responsible for endangering life and limb of the user or a third party and for damaging the device and other property as well!**



## 1.3 Service

*SPS electronic GmbH* will gladly be at your disposal if you need to find solutions to special problems, for doing repairs, for maintaining your equipment or for necessary alterations, in a nutshell for everything this manual doesn't tell you.

Please contact us via any of the below communication possibilities:

*SPS electronic GmbH*

Blätteräcker 18

74523 Schwäbisch Hall

Phone: (0 79 07) 8 78 - 29

Fax: (0 79 07) 8 78 - 22

e-mail: [service@spselectronic.com](mailto:service@spselectronic.com)

Internet: [www.spselectronic.com](http://www.spselectronic.com)

## 1.4 General instructions and regulations on safety

The compact test device *KT 3301E* is produced in compliance with the technical requirements at time of delivery.

Nevertheless, there can occur dangerous situations in connection with the tester if not operated properly by trained personnel or if used inexpertly or against regulations.

**Further to this manual the generally applicable legal regulations and other binding directives in regard to safety on the job, to accident prevention and to environmental protection must be observed.**



### 1.4.1 User's responsibility

- Only when **performing properly and reliably** the tester must be operated (pl. see 1.2.1)
- Equipment for protection and safety, locking devices and couplings, etc. must be checked by a technical expert at least once a year.  
The test results must be recorded in a **test certificate** and they must be kept in a file.
- **Instruction is compulsory** when operating, in any way, a machine or an equipment which may endanger the health and/or life of persons.  
People operating in any way a *KT 3301E* must acknowledge with their signature that they read and understood this operation manual, especially the paragraph on instructions and regulations on safety.
- Dangerous areas resulting from **incorporating** the tester into a system or device must be located and secured by the user/operator.  
When setting up or installing devices, systems or production facilities of different manufacturers or suppliers as well as after modifications by company or service personnel whereby electrical equipment is manipulated, the operator must, before starting the operation, conduct a precise check according to the accident prevention regulations VBG 4 and in compliance with the appropriate electro-technical regulations respectively.

### 1.4.2 Personnel

- Operating manual, instructions and regulations are an essential part of the tester and must, at all times, be within easy reach of all the persons operating in any way a *KT 3301E* tester.
- Before starting to operate a *KT 3301E* tester questions concerning their proper operation have to be answered by or discussed with the personnel in charge.
- Any operation in connection with a *KT 3301E* tester shall only be executed by personnel trained respectively, e.g. electricians and/or technical engineers and who have been authorized by the operator/user to do so.
- Trainees and persons under the age of 18 shall only operate a *KT 3301E* when supervised by trained personnel, like electricians and/or technical engineers.
- Adjustments/calibrations, maintenance and inspections have to be executed in time and according to specifications.

### 1.4.3 Safety equipment

The *KT 3301E* testers are, for the safety of the operating personnel, equipped with below safety equipment:

- safety current limiting for insulation test
- protective low voltage for protective wire test
- current limiting for high voltage test DC
- FI - fuse
- EMERGENCY STOP switch and loop for function test

### 1.4.4 Information on additional literature

The professional associations and trade unions have, for the safety of persons, published below literature:

- |                          |  |
|--------------------------|--|
| • VBG 1                  | Accident Prevention – General Regulations  |
| • VBG 4                  | Accident Prevention – Electrical Systems and Production Facilities   |
| • VBG 109                | Accident Prevention – First Aid  |
| • DIN VDE 0104           | Installation and Operation of Electrical Systems   |
| • DIN VDE 0106<br>part 1 | Protection against Electric Shock<br>Classification of Electrical and Electronical Production Facilities           |
| • DIN 40 008 part 3      | Safety Labels for Electrical Engineering;<br>Danger Signs and Supplementary Labels                                 |
| • DIN 40 050             | IP-Protective Systems; Contact and/or Foreign Matter, and Water<br>Protection for Electrical Production Facilities |
| • DIN VDE 0100           | Installation of Power Plants up to 1000 V  |



**This literature will give you additional information and it is an essential part of this operating manual. Their observance therefore is mandatory!**



**You can buy or order literature giving information on above instructions and regulations at or from:**

- **on laws and regulations**

at your book store/dealer

or

from Carl Heymanns Verlag KG, Luxemburger Straße 449, D-50939 Köln

- **on accident prevention regulations**

from a professional/trade association

or

from Carl Heymanns Verlag KG, Luxemburger Straße 449, D-50939 Köln

- **directives, safety regulations and respective leaflets of professional/trade associations**

from a professional/trade association

or

from Carl Heymanns Verlag KG, Luxemburger Straße 449, D-50939 Köln

- **DIN-Standards**

from Beuth Verlag GmbH, Burggrafestraße 6, D-10787 Berlin

- **VDE-Regulations**

from VDE-Verlag GmbH, Bismarckstraße 33, D-10625 Berlin

## 2 Hardware Description

### 2.1 Functions

With the tester *KT 3301E* safety tests for electrical devices according standardized test regulations (EN, IEC, VDE etc.) can be performed.

The standard device is designed as a stand-alone test station for one operator performing the following tests:

- continuity test  
24 V DC with current measurement between the connections
- protective wire test  
for measurement of resistance between ground and housing
- insulation test 500 V DC  
for measurement of resistance between connections and housing
- high voltage test 1.500 V DC, fixed voltage
- high voltage test AC, programmable
- function test  
with current input up to 16 A AC

**Note:**

The device's internal memory allows 50 different test programs at max.  
With the optionally available Remote Software 3332 DAT, the number of possible test programs is unlimited!

## 2.2 Technical data

<b>Dimensions and weight</b>			
width / depth/ height	approx. 490 / 460 / 220 mm		
weight	200 N (20.0 kg)		
<b>Environmental conditions</b>			
● temperature	operating: 15 °C – 40 °C non-operating: 5 °C – 60 °C		
● humidity	max. 70% (not condensating)		
<b>Connection specifications</b>			
● power supply	230 V ± 10% / 50 Hz (115 V / 60 Hz optional)		
● power consumption	max. 2300 VA		
<b>Operating specifications</b>			
● continuity test			
- test voltage	24V DC ± 2%		
- thresholds	programmable		
- measuring range	up to 500 mA DC (short-circuit)		
	<b>range</b>	<b>resolution</b>	<b>precision</b>
	0 up to 500 mA	1 mA	1.5% of max. value ± 1 mA
● protective wire test			
- test current	programmable from 10 up to 30 A AC		
- thresholds	programmable		
- measuring range	up to 500 mΩ (VDE 0700 / EN 60 335-1)		
	<b>range</b>	<b>resolution</b>	<b>precision</b>
	0 up to 500 mΩ	1 mΩ	1.5% of max. value ± 1 mΩ
	Typically achieved max. measurements: 20 A : 500 mΩ   25 A : 400 mΩ   30 A : 300 mΩ		
● insulation test			
- test voltage	500 V DC ± 2%		
- thresholds	programmable		
- short circuit current	< 10 mA DC		
- measuring range	5 MΩ and 50 MΩ		
	<b>range</b>	<b>resolution</b>	<b>precision</b>
	0.25 up to 5 MΩ	0.1 MΩ	2.5% of max. range value
	5 up to 50 MΩ	0.5 MΩ	5% of max. range value



## ...TECHNICAL DATA

● high voltage test DC			
- test voltage	1500 V DC $\pm$ 2%		
- thresholds	programmable		
- short-circuit current	<10 mA DC		
- measuring range	0 up to 4 mA DC		
	<b>range</b> 0.1 up to 4 mA	<b>resolution</b> 0.01 mA	<b>precision</b> 2.5% of max. value $\pm$ 0.01 mA
● high voltage test AC			
- test voltage	250-2500 V AC $\pm$ 2% (standard), 250-5000 V AC $\pm$ 2% (optional)		
- thresholds	programmable		
- measuring range	0 up to 100 mA AC		
	<b>range</b> 0 up to 10 mA 0 up to 100 mA	<b>resolution</b> 0.1 mA 1 mA	<b>precision</b> 2.5% of max. value $\pm$ 0.1 mA 2.5% of max. value $\pm$ 1 mA
● function test (current input up to 16 A AC)			
- test voltage	internal: mains voltage (max. 10 A) external: up to 400 V AC (max. 16 A)		
- thresholds	programmable		
- measuring range	0-16 A AC		
	<b>range</b> 0 up to 16 A	<b>resolution</b> 0.1 A	<b>precision</b> 1.5% of max. value $\pm$ 0.1 mA
<b>Additional features</b>			
<ul style="list-style-type: none"> <li>● 19" / 5 HU housing with integrated keyboard and LC display</li> <li>● connection of DUT via high voltage connection socket</li> <li>● RS 232 – interface for printer connection or remote control</li> <li>● menu-driven programming (up to 50 test programs programmable)</li> <li>● continuity test 24 V DC max 0.6 A</li> <li>● protective wire test with 4-wire-technique; AC-current source up to 30 A AC</li> <li>● safety current limited voltage source for insulation and high voltage test DC</li> <li>● protective low voltage for protective wire test</li> <li>● function test up to 400 VAC / 16 A for external feed-in</li> </ul>			

## 2.3 Design and functions

### 2.3.1 Front

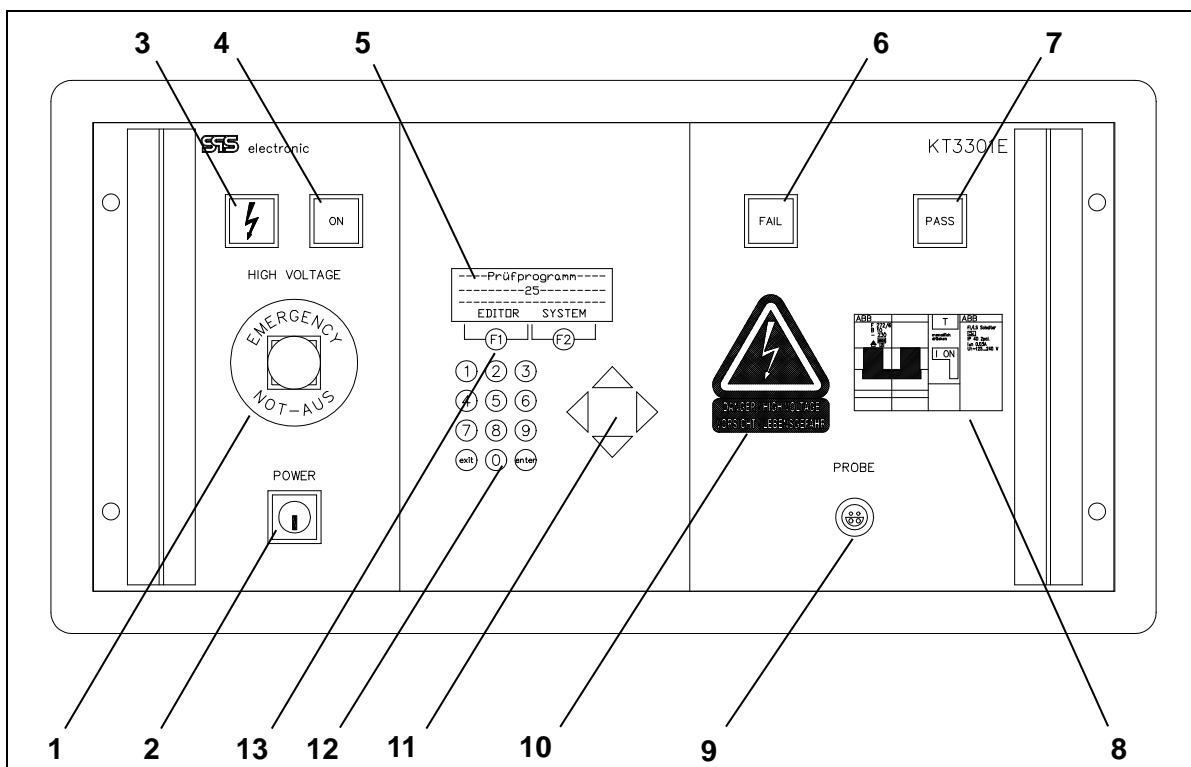

Front of *KT 3301E*

- 1 EMERGENCY STOP switch
- 2 key switch to switch device on or off
- 3 red warning light HIGH VOLTAGE
- 4 ON key to set device active
- 5 LC-display
- 6 red light fail  
lights up if test failed or DUT did not pass test
- 7 green light pass  
lights up if DUT passed test
- 8 FI fuse
- 9 connection socket for test prod
- 10 warning sign
- 11 cursor keys for selections
- 12 number keys for inputs, exit key (= F1), enter key (= F2)
- 13 operating keys F1 and F2

### 2.3.2 Back

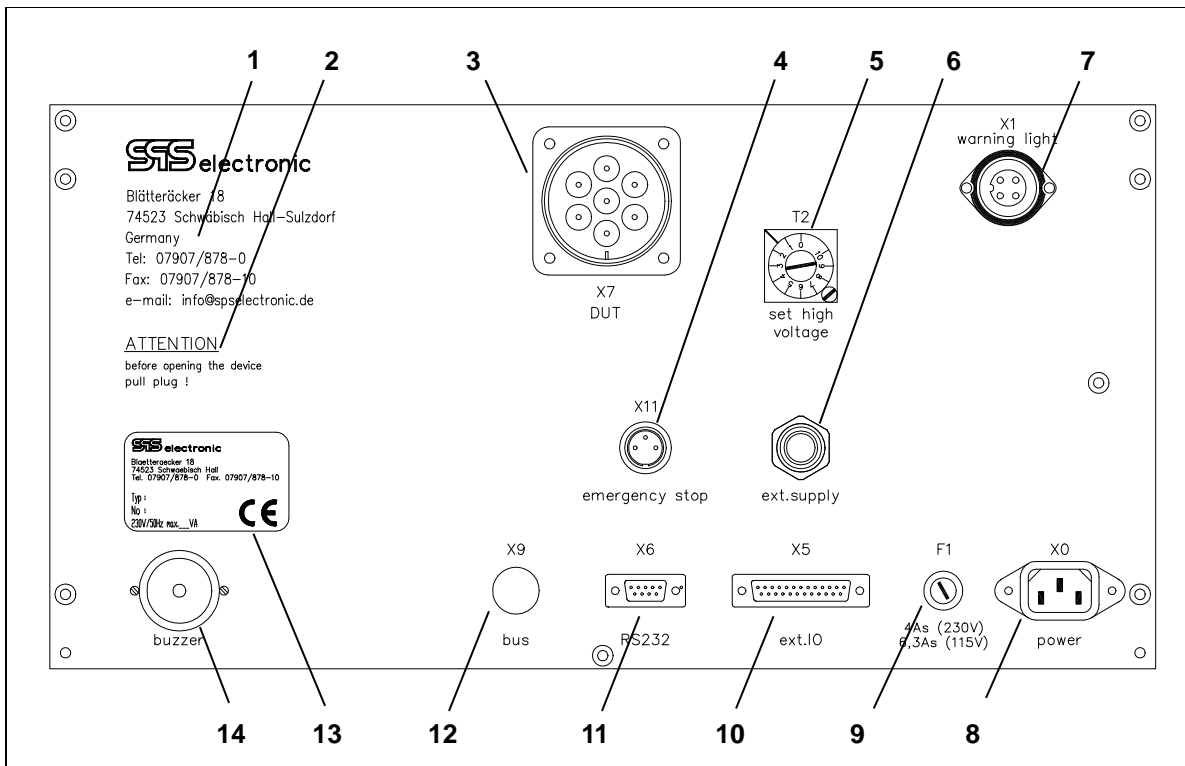

Back of KT 3301E

- 1 address of manufacturer
- 2 safety instruction:  
*ATTENTION*  
*before opening device*  
*pull plug!*
- 3 DUT connector
- 4 socket for EMERGENCY STOP loop
- 5 control knob for setting high voltage value
- 6 outlet for lines of external supply of FT-test
- 7 connection socket for external warning lights
- 8 cold appliance socket for power cable
- 9 main fuse
- 10 I/O – outputs for connection of i.e. external control desk
- 11 RS 232 - interface for connection printer or PC
- 12 space for I2C bus (for future extensions)
- 13 type label with
  - address of manufacturer
  - device designation (type)
  - serial number (no)
  - max. power consumption at 230 V / 50 Hz in VA
  - CE mark
- 14 buzzer

## 2.4 Expansions, options and accessories

### Expansions for test acc. to EN 60 335

- connection desk *AI / S 3301*
  - PVC housing; DUT connection via:
    - \* earthed socket
    - \* CEE 16-6h socket
    - \* 4 mm lab sockets
  - 2 m of connecting cable, with 7-pole high voltage socket
- two-hand operation *B1 / S3301*
  - PVC housing
  - approved/certified safety relay
  - 2 m of connecting cable with Dsub25 socket
- test hood *HB 3300A*

### Options

- power supply 115 V / 60 Hz
- 5 m of silicon connecting cable for protective wire test probes
- external feed-in for function test
- special designed versions of the *KT 3301E* with higher HV-voltages

### Accessories

- plug-in housing *EH 4905-y*  
*19" / 5HU, 400mm deep*
- test prod *PE 13-i*
  - stationary tungsten tip
  - without start key
  - 2.0 m of silicon connecting cable
- test prod *PE 18-i*
  - stationary tungsten tip
  - with start key
  - 2.0 m of silicon connecting cable
- external warning light set



... ACCESSOIRES

- printer DK 23 with connecting cable
  - type: EPSON LX 300
  - matrix printer for standard paper
  - endless form or single sheet feeder
  - RS 232 – interface and parallel interface
- test certificate according ISO 9000
- software for data acquisition and remote control 3332 *DAT* WINDOWS surface



Accessories can be ordered directly from *SPS electronic GmbH*.  
Please write to our sales department for any inquiries you may have  
or for placing your orders:

*SPS electronic GmbH*  
Blätteräcker 18  
74523 Schwäbisch Hall  
Phone: (0 79 07) 8 78 - 0  
Fax: (0 79 07) 8.78 - 99  
e-mail: [info@spselectronic.com](mailto:info@spselectronic.com)  
Internet: [www.spselectronic.com](http://www.spselectronic.com)

## 3 Operation

### 3.1 Start of operation

#### 3.1.1 Requirements

The tester *KT 3301E* as well as all the electrical connections and cables must function and perform properly and reliably.  
 Only authorized personnel, like electricians or electrical engineers or personnel supervised by same shall operate a tester.  
 The generally applicable safety regulations (pl. see paragraph 1.4) and the generally valid legal regulations as well as any other applicable and valid regulations as to safety on-the-job, accident prevention and environmental protection have to be observed and persons working in such an area, have to be instructed respectively.



There is danger of life caused by electric current or voltage if not dealing properly with electrical systems!



The power cable of DUT has to have an earthed plug (plug with three connections L-N-PE) !



The testing voltage is potential free (acc. EN 50 191) and must not be grounded!  
 Otherwise, there is danger of hazard, destruction and bad measurements!



#### 3.1.2 Installation of test station

1. choose a level, clean and dry base for your test station
2. if necessary turn off power switch (key switch) at tester
3. plug power cable at the back of tester into cold appliance socket and connect to power supply
4. connecting test probe
5. if required connect external devices to interfaces:
  - operating desk to I/O interface at the back *and/or*
  - connection desk to 7 pole HV socket at the back *and/or*
  - PC or printer to RS 232 interface at the back

### 3.1.3 Connecting DUT

Connect power connection of DUT to the tester:

- to the high-voltage connection socket (at the back)
- or
- to the socket or lab sockets at connector desk (expansion)

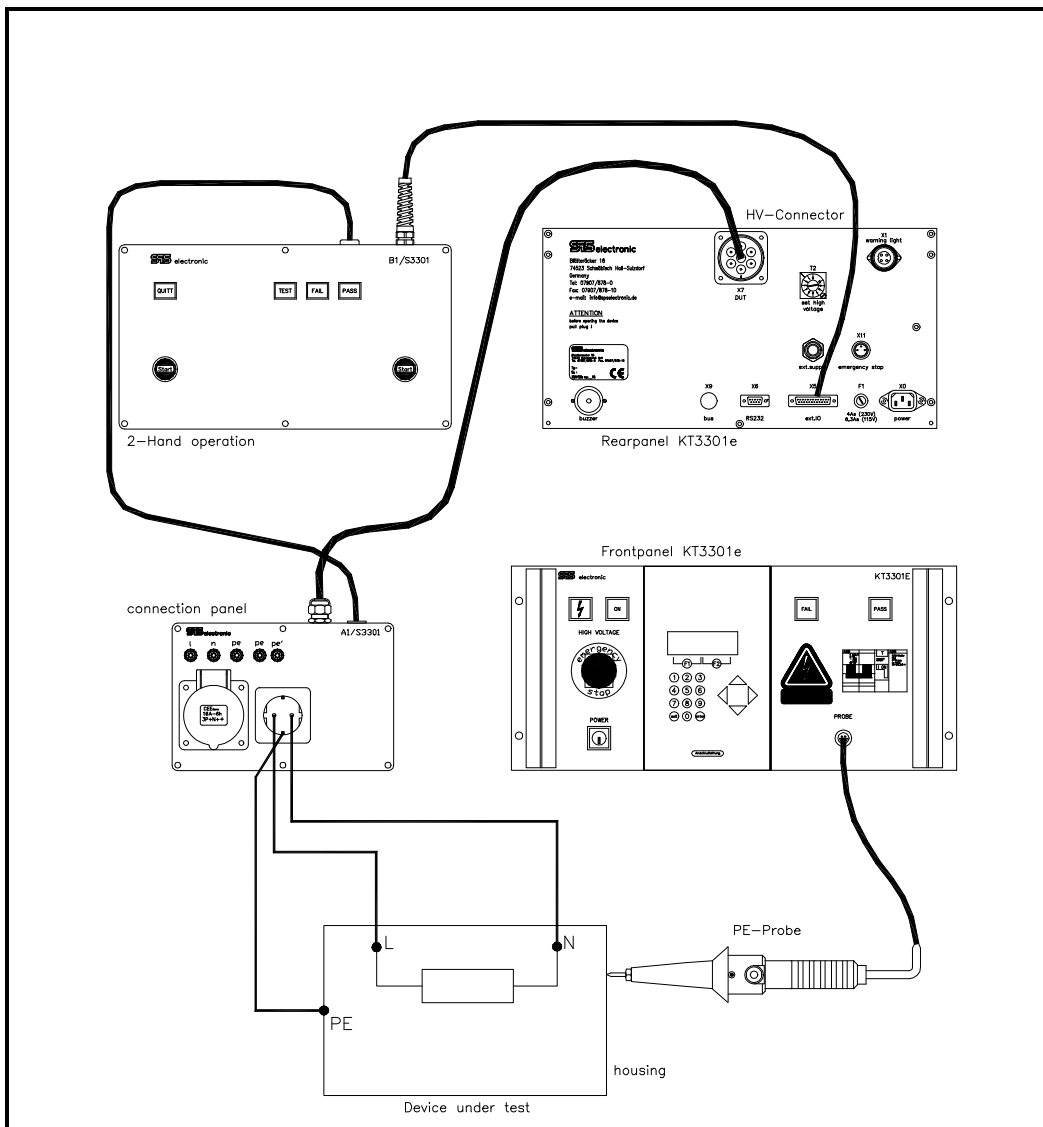

### Connecting scheme



**connecting scheme KT 3301E**

## 3.2 Changing of program settings

To find your way through the program, below symbols will be used:

-  function of LCD display
-  input

Displays on LCD appear in `typewriter` characters



**For entry of letters, numbers and special characters with number keys  
(needed when entering name of program):**

- with key ① 1 character forward
- with key ④ 1 character backward
- with key ② 5 characters forward
- with key ⑤ 5 characters backward
- with key ③ 10 characters forward
- with key ⑥ 10 characters backward

With the cursor keys the cursor can be moved to a position in the program name to enter characters.





Basic display will appear after switching on of tester:

 `Pr.01      NONAME`  
`with <START> to test`  
`< menu >   < prgnr >`

After pressing key F1 (< menu >), menu password has to be entered. (depends on the setting »password« in *system parameter*)

Display of parameter groups:

 `→ test parameter`  
`system parameter`

1. select parameter group:
  -  with cursor keys, set arrow (→) to the desired parameter group
  -  acknowledge selection with F2 (< select >)
2. have parameter of a parameter group displayed or changed:
  - for changing of test parameter pl. see p. 25ff
  - for changing of system parameter pl. see p. 22



### 3.2.1 Programming individual test programs

The compact test device **KT 3301E** can store up to 50 different testing programs. Delivered devices contain the default test program on program number 1, called "Noname". It contains all available tests with their default values.

The program numbers 2 to 50 are deactivated since all "test time" parameters are set to 0.0s.

To arrange an individual test program, proceed the following steps:

1. Set the tester back to basic display:  
switch the **KT 3301E** off and on, or press <F1> several times
2. choose the desired number of test program (1-50) :
  - press <F2> (Prgno.)
  - enter the desired number of test program with number or cursor keys
  - acknowledge your selection with <F2>
3. to upset the test parameters:
  - with cursor keys, scroll to the test to be changed
  - please see chapter 3.3, page 27ff. for a detailed description of all test parameters
  - if you wish a test to be skipped, set *TEST TIME* to 0.0

Every change in a test program will be saved immediately by pressing <F2> (<OK>).

In case you made silly changes and wish to reset parameters to former status, simply press <F1> (<CANCEL>)

### 3.2.2 Changing of system parameters

After having preselected the parameter group `system parameter`, you can select a function (pl. see p.21). To change it:

1. go to `system parameter` with cursor keys and select with F2 (< select >)
2. changing of presetting:

 LANGUAGE ###

 press F2 (< select >)

 German

 English

 select desired language with cursor keys and acknowledge with F2 (< OK >)  
all the displays will be switched automatically to the chosen language

 OPERATING MODE ###

 press F2 (< select >)

 manual

digital (*program selection via external I/O*)

automatic (*remote control via PC to RS 232 interface*)

 preselect operating mode with cursor keys and acknowledge selection  
with F2 (< OK >)

## ... CHANGING OF SYSTEM PARAMETERS

 SYSTEM TIME ##:##

 press F2 (< select >)

 08:00

 enter time (hours : minutes) with numeric keys and acknowledge with F2 (< OK >).

 SYSTEM DATE ##.##.####

 press F2 (< select >)

 06.10.1998

 enter date (day.month.year) with numeric keys and acknowledge with F2 (<OK>)

 BUZZER ###

 press F2 (< select >)

 soft

loud

off

 select volume with cursor keys and acknowledge selection with F2 (< OK >)

 PRINT FORMAT ###

 press F2 (< select >)

 condensed *(print test protocols with format 40 characters per line)*

page *(print test protocol page by page)*

endless *(print test protocol continuously)*

line *(minimum protokol: prints only test results [GOOD / BAD] )*

data logger *(compact version for a data logger)*

 select printer format with cursor keys and acknowledge with F2 (< OK >)  
(for examples for above formats, pl. see appendix)

 PROTOCOL ###

 press F2 (< select >)

 never *(do not print test results)*

pass *(print test results only when test was passed)*

error *(print test results only when test was not passed)*

always *(print results after each test)*

 select protocol setting with cursor keys and acknowledge with F2 (< OK >)

 PASSWORD ###

 press F2 (< select >)

 proppassword *(access to program selection permitted)*

menupassword *(access to preset programs permitted)*

 select password type with cursor keys and acknowledge with F2 (< select >)





 password please:

 enter current password with numeric keys







(for devices to be delivered the password is 0000 [deactivated] )



### ... CHANGING OF SYSTEM PARAMETERS

-  new password?
    -  press F2 (< select >)
    -  enter new password with numeric keys
  -  store password?
    -  press F2 (< select >)
- ⇒ the new password is stored and activated (if other than 0000)

#### SPECIAL FUNCTIONS

-  press F2 (< select >)
-  Multistart [YES/NO] - (*Chooses whether the Motor Stop function is available for usage (see Appendix A-3)*)
-  PE-Res.Offset [000-500 mΩ] - (*The chosen value is subtracted from all PW-measurements, to compensate the influence of measuring lines*)
-  DAT3800 Lizeuse [Password/No] (*To enter the license password of DAT3800*)
-  HV-Ramp down [YES/NO] - (*If YES, the test voltage is ramped-down at the end of an HV-AC test. If NO, voltage is switched off immediately.*)
-  Motor Stop [YES/NO] - (*activates or deactivates the function*)

#### Functioning of "Motor Stop":

To speed up the testing performance, the stepping motor remains in its last position, if there's no need to recalibrate the testing voltage.

The following conditions must be met:

- Ramp time = 0
- Ramp down = no
- testing voltage must be identical to the previous test step
- no change of AC/DC – parameters (frequency)

If any of these conditions are *not* fulfilled, the stepping motor will step back to zero voltage.

#### Advantages of "Motor stop":

The execution of several homogeneous tests, with which no voltage ramp is necessary, is accelerated considerably.



In addition, the wear of the stepping motor is reduced.

#### SERIAL NUMBER ###

-  press F2 (< select >)

-  yes *requesting input of a serial number before each test (up to 20 characters from 0 to 9 possible)*
- no *no serial number*

#### HEADING LINE ###

-  press F2 (< select >)
-  enter heading line (up to 40 characters) with cursor keys (pl. see hint at p.21)
-  acknowledge input with F2 (< OK >)



**Serial number and heading line are only required for print-out.**

### 3.2.3 Changing of test parameters

After having preselected the parameter group `test` parameter, you can select a test function: (pl. see p. 21)

```

Multistart  *)
→ CT test
  PW test
  IS test
-----
  HV-DC test
  HV-AC test
  FT test
    
```

\*) the entry "Multistart" is only visible with `Multistart = YES` in the system parameters.

1. select test function :

- ☞ with cursor keys, set arrow (→) to the desired parameter group
- ☞ acknowledge selection with F2 (< select >)

```

PE test
PROGRAM NAME
NONAME
< back >   < select >
    
```

(first test parameter)

2. select test parameter:

- ☞ go to desired test parameter with cursor keys
- ☞ acknowledge selection with F2 (< select>)

For a detailed description of the test parameters, please see paragraph 3.3, page 27ff.

#### The "Multistart" testing mode

If the option `Multistart = YES` has been set in *System parameter / Special functions*, then the testparameter menu will offer the additional option "Multistart" (see figure above).

By setting of `Multistart = 2/3/4` it is possible to excute several tests one after another.

The default value for this parameter is "1" (normal operation without multistart).

For a detailed description of the multistart functionality, please see annex A-3 Multistart .

### 3.3 Executing tests

1. If provided for, switch on external devices (control desk, PC, printer)
2. Switch on power switch (key switch) at tester
  - ⇒ tester initializes itself automatically.
  - after about five seconds basic display will appear

Basic display after switching on of tester:



```

Pr.01      NONAME
with <START> to test

< menu >  < prgnr >
```

3. Select one of below functions:

- **Executing test with preset program**  
(the program number is displayed)

- ☞ press key START
- ☞ if displayed, press key ON:



```

Please press
key ON

<cancel>
```

- ☞ enter serial number if necessary  
(depending on system parameter serial number, pl. see paragraph 3.2.2)  
⇒ test is started
- ☞ for individual test steps press key START if necessary

- **Loading of a different program**

- ☞ press F2 to select < prgno >
- ☞ enter program password (if active)
- ☞ enter desired program number
- ☞ press F2 (< OK >)
- ⇒ program is being loaded
- or*
- ☞ change step by step with cursor keys
- ⇒ program is being loaded

- **Changing of program settings**

- ☞ press F1 to select < menu >
- ☞ enter menu password (if active)
- ☞ for changing of preset programs pl. see paragraph 3.3, page 27ff.



### 3.3.1 Continuity test

For the continuity test 24 V DC are applied between the connections **L** and **N**, the current flowing (up to 500 mA) is being measured.

If there are values of current **between**  $I_{min}$  and  $I_{max}$ , DUT **passed** the continuity test.

Green light *pass* will light up.

If there are values of current **smaller than**  $I_{min}$  or **larger than**  $I_{max}$ , DUT **failed** continuity test, i.e. DUT is not contacted or its insulation is insufficient

Red light *fail* will light up.

The testing voltage of the CT test is not stabilized, and may vary depending on load.



#### Proceeding

After having chosen the parameter group `test parameter` (see p. 21) you'll have to choose the test funktion `CT test`:

- ☞ with cursor keys, set arrow (→) to `CT test`
- ☞ acknowledge selection with F2 (< select >)

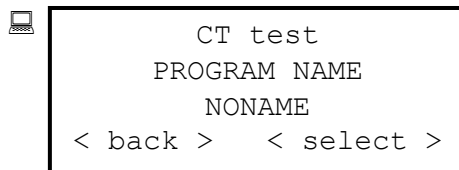

(first test parameter)

#### Selection of test parameter:

- ☞ go to desired test parameter with cursor keys
- ☞ acknowledge selection with F2 (< select >)

#### Test parameters of CT test

- ☞ PROGRAM NAME ###
  - ☞ enter program name with numeric keys (pl. see hint on p.21)
  - ☞ acknowledge input with F2 (< OK >)
- ☞ EXECUTE
  - yes     *(execute continuity test between L and N [for 1 sec])*
  - no      *(no continuity test)*
  - ☞ acknowledge selection with F2 (< OK >)
- ☞ min. current ### mA
  - ☞ enter numeric value (000 – 500) with cursor or numeric keys
  - ☞ acknowledge input with F2 (< OK >)
- ☞ max. current ### mA
  - ☞ enter numeric value (000 – 500) with cursor or numeric keys
  - ☞ acknowledge input with F2 (< OK >)

### 3.3.2 Protective wire test

The protective wire test measures the resistance between PE (earthing) and housing of DUT. The resistance has to be as small as possible.

Otherwise contact between PE and housing is insufficient.

If there are values of resistance **between  $R_{\min}$  and  $R_{\max} \leq 500 \text{ m}\Omega$**  (acc. to EN 60 335), DUT **passed** protective wire test, i.e. DUT is earthed acc. to regulations.

Green light *pass* will light up.

If there are values of resistance **smaller than  $R_{\min}$  or larger than  $R_{\max}$** , DUT **failed** protective wire test, i.e. its earthing is insufficient.

Red light *fail* will light up.

To obtain a positive result with the protective wire test, three measurements at different points on the housing of the DUT should be executed.



**When assembling various systems the earthing at the connection points can be interrupted so that for example the sides of the housing are sufficiently earthed, however the back of the housing is not sufficiently earthed.**

#### Proceeding

After having chosen the parameter group `test parameter` (see p. 21) you'll have to choose the test funktion `PE test`:

- ☞ with cursor keys, set arrow ( $\rightarrow$ ) to `PE test`
- ☞ acknowledge selection with F2 (`< select >`)

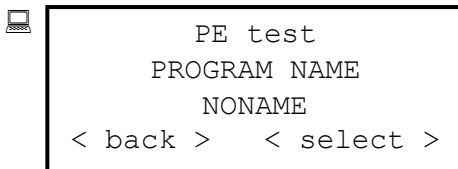



(first test parameter)

#### Selection of test parameter:

- ☞ go to desired test parameter with cursor keys
- ☞ acknowledge selection with F2 (`< select >`)

#### Test parameters of PE test

-  `PROGRAM NAME ###`
  - ☞ enter program name with numeric keys (pl. see hint on p. 21)
  - ☞ acknowledge input with F2 (`< OK >`)
-  `NUMBER ##`
  - ☞ enter numeric value (from 00 to 99) with cursor or numeric keys
  - ☞ acknowledge input with F2 (`< OK >`)



## ... TEST PARAMETER PE TEST

TEST TIME ##.# s  
 ⤴ enter numeric value (00.0 – 60.0) with cursor or numeric keys  
 ⤴ acknowledge input with F2 (< OK >)

START MODE  
 manual (with key *START*)  
 automatic (when contacting *DUT*)  
 ⤴ selection of desired start mode  
 ⤴ acknowledge selection with F2 (< OK >)

CURRENT ## AAC  
 ⤴ enter numeric value (10 – 30) with cursor or numeric keys  
 ⤴ acknowledge input with F2 (< OK >)

TEST METHOD  
 EN 60335  
 EN 60204  
 ⤴ choose the desired method with cursor keys  
 ⤴ acknowledge selection with F2 (< OK >)

**PE test acc. to EN 60 335:**

MAX. NO-LOAD VOLTAGE  
 12 VAC  
 ⤴ enter desired no-load voltage  
 ⤴ acknowledge selection with F2 (< OK >)

MIN. RESISTANCE ### mΩ  
 ⤴ enter numeric value within measuring range (from 0 to 499)  
 ⤴ acknowledge input with F2 (< OK >)

MAX. RESISTANCE ### mΩ  
 ⤴ enter numeric value within measuring range (from 1 to 500)  
 ⤴ acknowledge input with F2 (< OK >)

**PE test acc. to EN 60 204:**

CROSS SECTION #.# qmm  
 all (same cross section of a line for all test steps)  
 individual (determine cross sections of a line for individual test steps)

⤴ enter desired function

- when selecting *all* change cross section of a line with cursor keys ▲ and ▼
- when selecting *individual* select one test step each resp. with cursor keys ▲ and ▼ and change cross section of a line each resp. with cursor keys ◀ and ▶

### 3.3.3 Insulation test

For the insulation test the connections L and N are bridged and voltage is applied. If DUT is sufficiently insulated, no partial current will flow back via its PE-line.

Therefore resistance between N+L and PE must be as high as possible.

If there are values of resistance **larger than  $R_{min}$** , DUT **passed** insulation test, i.e. DUT is insulated acc. to regulations.

Green light *pass* will light up.

If there are values of resistance **smaller than  $R_{min}$**  DUT **failed** insulation test, i.e. its insulation is insufficient.

Red light *fail* will light up.

#### Switching of measuring range:

Switching the measuring range between 5 MOhm and 50 MOhm is achieved by specifying the "R min" parameter:

$R_{min} \leq 5 \text{ MOhm} \Rightarrow \text{range } 5 \text{ MOhm}$

$R_{min} > 5 \text{ MOhm} \Rightarrow \text{range } 50 \text{ MOhm}$

#### Proceeding

After having chosen the parameter group `test parameter` (see p. 21) you'll have to choose the test funktion `IS test`:

- ☞ with cursor keys, set arrow ( $\rightarrow$ ) to `IS test`
- ☞ acknowledge selection with F2 (`< select >`)



```

IS test
PROGRAM NAME
NONAME
< back >  < select >
```

(first test parameter)



#### Selection of test parameter:



- ☞ go to desired test parameter with cursor keys
- ☞ acknowledge selection with F2 (`< select >`)









### Test parameters of IS test:

-  PROGRAM NAME ###



  -  enter program name with numeric keys (pl. see hint on p.21)
  -  acknowledge input with F2 (< OK >)
  
-  TEST TIME ##.# s

  -  enter numeric value (00.0 – 60.0) with cursor or numeric keys
  -  acknowledge input with F2 (< OK >)
  
-  1x AT SOCKET

  - yes           *(before test with probe, measuring at socket)*
  - no            *(immediate test with probe, no measurement at socket)*
  -  preselect desired method
  -  acknowledge selection with F2 (< OK >)
  
-  NUMBER (PROBE) ##

  -  enter numeric value with cursor or numeric keys (from 00 to 99)  
(in reference to IS tests with test probe)
  -  acknowledge input with F2 (< OK >)
  
-  VOLTAGE 500 V

(for IS test, test voltage is predetermined)
  
-  THRESHOLD Rmin ##.## MΩ

  -  enter numeric value with cursor or numeric keys (from 00.00 to 50.00)
  -  acknowledge input with F2 (< OK >)

### 3.3.4 High voltage test DC

For the high voltage test the connections L and N are bridged and voltage is applied. If DUT is sufficiently insulated, no partial current will flow back via its PE-line.

Therefore resistance between N+L and PE must be as high as possible.

If there are values of current **smaller than  $I_{max}$** , DUT **passed** the high voltage test.

Green light *pass* will light up.

If there are values of current **larger than  $I_{max}$** , DUT **failed** high voltage test, i.e. its insulation is insufficient

Red light *fail* will light up.

#### Proceeding

After having chosen the parameter group test parameter (see p. 21) you'll have to choose the test funktion HV-DC test:

- ☞ with cursor keys, set arrow (→) to HV-DC test
- ☞ acknowledge selection with F2 (< select >)

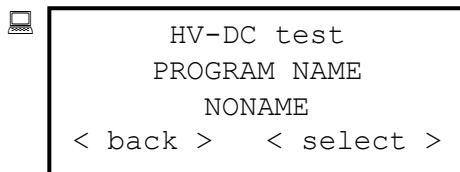

(first test parameter)

#### Selection of test parameter:

- ☞ go to desired test parameter with cursor keys
- ☞ acknowledge selection with F2 (< select >)



#### Test parameters of HV-DC test



- ☞ PROGRAM NAME ###
  - ☞ enter program name with numeric keys (pl. see hint on p.21)
  - ☞ acknowledge input with F2 (< OK >)
- ☞ TEST TIME ##.# s
  - ☞ enter numeric value (00.0 – 60.0) with cursor or numeric keys
  - ☞ acknowledge input with F2 (< OK >)





... TEST PARAMETER HV-DC TEST

-  1x AT SOCKET

  - yes                   *(before test with probe, measuring at socket)*
  - no                   *(immediate test with probe, no measurement at socket)*
  -  preselect desired method
  -  acknowledge selection with F2 (< OK >)
  
-  NUMBER (PROBE) ##

  -  enter numeric value with cursor or numeric keys (from 00 to 99)  
(in reference to HV tests with test probe)
  -  acknowledge input with F2 (< OK >)
  
-  VOLTAGE 1500 V

(for HV-DC test, test voltage is predetermined)
  
-  max. CURRENT #.# mA

  -  enter numeric value (from 0.0 to 4.0) with cursor or numeric keys
  -  acknowledge input with F2 (< OK >)

### 3.3.5 High voltage test AC

For the high voltage test the connections L and N are bridged and voltage is applied. If DUT is sufficiently insulated, no partial current will flow back via its PE-line.

Therefore resistance between N+L and PE must be as high as possible.

If there are values of current **smaller than  $I_{max}$** , DUT **passed** the high voltage test.

Green light *pass* will light up.

If there are values of current **larger than  $I_{max}$** , DUT **failed** high voltage test, i.e. its insulation is insufficient

Red light *fail* will light up.

#### Proceeding

After having chosen the parameter group test parameter (see p. 21) you'll have to choose the test funktion HV-AC test:

- ☞ with cursor keys, set arrow (→) to HV-AC test
- ☞ acknowledge selection with F2 (< select >)

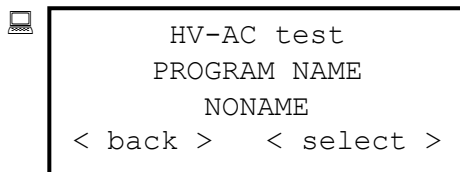

(first test parameter)

#### Selection of test parameter:

- ☞ go to desired test parameter with cursor keys
- ☞ acknowledge selection with F2 (< select >)



#### Test parameters of HV-DC test

- ☞ PROGRAM NAME ###
  - ☞ enter program name with numeric keys (pl. see hint on p.21)
  - ☞ acknowledge input with F2 (< OK >)
- ☞ TEST TIME ##.# s
  - ☞ enter numeric value (00.0 – 60.0) with cursor or numeric keys
  - ☞ acknowledge input with F2 (< OK >)





## ... TEST PARAMETER HV-AC TEST

 NUMBER HV-AC TEST ##

-  enter numeric value with cursor or numeric keys (from 00 to 99)  
(in reference to HV tests with test probe)
-  acknowledge input with F2 (< OK >)



 min. voltage #### VAC

-  enter numeric value (from 0250 to 5000) with cursor or numeric keys
-  acknowledge input with F2 (< OK >)



*Only for devices without step-motor:*

 Umin: #### VAC



U : #### VAC

-  adjust the no-load voltage with the control knob at back of device  
(**Attention!** For safety reasons, the high voltage is not put through to the connections.  
With higher loads, possibly you'll have to set the no-load voltage a little bit higher.)
-  to finish this procedure, press F1 (< cancel >)

 min. CURRENT #.# mA

-  enter numeric value (from 0.0 to 99.9) with cursor or numeric keys
-  acknowledge input with F2 (< OK >)

 max. CURRENT #.# mA

-  enter numeric value (from 0.0 to 99.9) with cursor or numeric keys
-  acknowledge input with F2 (< OK >)

### 3.3.6 Function test

For the function test an alternating voltage between L and N is applied and alternating current (up to 16 A AC) is being measured.

If there are values of current between  $I_{\min}$  and  $I_{\max}$  measured continuously longer than the preset pass time, DUT passed the function test.

Green light *pass* will light up.

If the pass time is not reached DUT failed the function test.

Red light *fail* will light up.

#### Proceeding

After having chosen the parameter group `test parameter` (see p. 21) you'll have to choose the test funktion `FT test`:

- ☞ with cursor keys, set arrow (→) to `FT test`
- ☞ acknowledge selection with F2 (< select >)

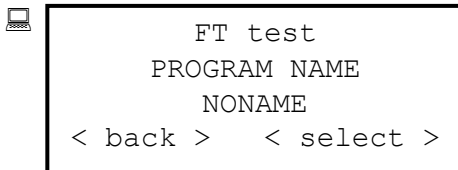

(first test parameter)

#### Selection of test parameter:















- ☞ go to desired test parameter with cursor keys
- ☞ acknowledge selection with F2 (< select >)

#### Test parameters of FT-Test

- ☞ PROGRAM NAME ###
  - ☞ enter program name with numeric keys (pl. see hint on p.21)
  - ☞ acknowledge input with F2 (< OK >)
- ☞ NUMBER #
  - ☞ enter numeric value (from 0 to 4) with cursor or numeric keys
  - ☞ acknowledge input with F2 (< OK >)
- ☞ START MODE FT
  - manual (with *START* key)
  - with adapter (start signal has to be applied during entire test)
  - immediately (test starts after last test)
  - with test hood (start signal [ext. I/O] has to be applied statically)

## ... TEST PARAMETER FT-TEST

The next 5 parameters are repeated for each step.  
(NN means step number (1 to 4) )

-  TEST TIME NN ##.# s
  -  enter numeric value with cursor or numeric keys (from 00.0 to 60.0)
  -  acknowledge input with F2 (< OK >)
  
-  PASS TIME NN ##.# s
  -  enter numeric value with cursor or numeric keys (from 00.0 to 60.0)
  -  acknowledge input with F2 (< OK >)
  
-  min. CURRENT NN ##.# AAC
  -  enter numeric value with cursor or numeric keys (from 00.0 to 16.0)
  -  acknowledge input with F2 (< OK >)
  
-  max. CURRENT NN ##.# AAC
  -  enter numeric value with cursor or numeric keys (from 00.0 to 16.0)
  -  acknowledge input with F2 (< OK >)
  
-  VOLTAGE NN ### VAC *(presently without influence on test internal feed-in with 230 VAC and external feed-in up to 400VAC)*
  -  enter numeric value with cursor or numeric keys (from 000 to 400)
  -  acknowledge input with F2 (< OK >)

## 3.4 Remote control via RS 232

1. From system parameter (see 3.2.2, S.22) select OPERATING MODE automatic

A message appears on display:

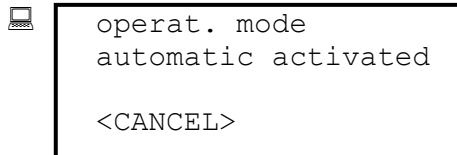

```

operat. mode
automatic activated

<CANCEL>

```

⇒ the device is now in remote mode and remains in this mode also after powering the device off and on

To leave this mode:

- ☞ press F1 (<CANCEL>) for about 3 sec and
  - ☞ turn power switch off and on
- ⇒ tester initializes itself.

2. The tester can be controlled by commands described in the following chapter.
3. The evaluation of measuring results (pass, fail) is up to the user (PC).

Below please find description and syntax of commands for data exchange between tester *KT 3301E* and PC. Data exchange is made via serial interface.

### 3.4.1 Syntax

- command format  
[command]<LF>      max. length 40 characters
- answer format  
[answer]<LF>
- commands
  - \*[global command]      permanently available command
  - [local command]      command depending on structure which can only be executed under certain conditions
- global and local commands
 

[execute command]	controls tester directly
[configuration command]<SP>[parameter]	sets device parameter
[data request command]?	expects a value

### 3.4.2 Global commands

*IDN?	verifies device identification <i>example for answer: KT3001D, Ver. 1.07, 07.07.1999&lt;LF&gt;</i>										
*VER?	verifies version of device control <i>example for answer: 600&lt;LF&gt;</i>										
*MOD?	verifies current device mode <i>example for answer: 5&lt;LF&gt;</i>										
*STA?	reads status register <i>example for answer: 3&lt;LF&gt;</i>										
*LLO<status>	Enables or disables the possibility of test abort by the button F1 on the device keyboard, according to the value of <i>status</i> : 0 = enable abort 1 = disable abort (active until power off)										
*LLO?	queries if status is locked or unlocked <i>example for answer: 0&lt;LF&gt; unlocked</i> <i>1&lt;LF&gt; locked</i>										
*INP<digital input>?	Reads the status of digital input. Possible answers are: 0 = off, 1 = on. Digital input format ist NN (always 2 digits). <i>example for answer: 0&lt;LF&gt;</i> <u>Standard digital inputs:</u> <table border="0" style="margin-left: 20px;"> <tr> <td>DEVICE NOT AUS</td> <td style="text-align: right;">15</td> </tr> <tr> <td>DEVICE ON</td> <td style="text-align: right;">16</td> </tr> <tr> <td>INT_START (PE test probe)</td> <td style="text-align: right;">13</td> </tr> <tr> <td>EXT_START (2-hand control, test hood)</td> <td style="text-align: right;">08</td> </tr> <tr> <td>EXT_ACK</td> <td style="text-align: right;">06</td> </tr> </table>	DEVICE NOT AUS	15	DEVICE ON	16	INT_START (PE test probe)	13	EXT_START (2-hand control, test hood)	08	EXT_ACK	06
DEVICE NOT AUS	15										
DEVICE ON	16										
INT_START (PE test probe)	13										
EXT_START (2-hand control, test hood)	08										
EXT_ACK	06										
*ERR?	reads first (oldest) stored error from error queue and deletes it there error-ID and description are divided by » , « error queue is a first-in, first-out (FIFO) and can store maximally 10 errors if error buffer is full, then error »200,Queue Overflow« will be stored on the last position <i>example for error: 0, No error&lt;LF&gt;</i>										
*CEQ	clears all errors from error queue.										
*CLS	clears status register and error queue as well as input and output buffer for serial communication. Breaks the testing (if running) and puts device in idle state. The parameters set by commands CONF remain but the type of latest test and ist result are cleared.										
*RST	returns the device to the power-on startup conditions. It is the same as *CLS command but all test parameters are set on their default values.										

### 3.4.3 Local commands

#### ● CONF group

##### Continuity test

There is not any parameter to set.

##### Protective wire test

CONF:PW:TIME<test time>	sets test time: range 0.1 – 99.9; default 5.0 [s]
CONF:PW:TIME?	queries currently set test time
CONF:PW:CURR<test current>	sets test current: range 10 – 30; default 10 [A]
CONF:PW:CURR?	queries currently set test current
CONF:PW:MODE:OFF MAN AUTO	sets type of starting mode, whereby OFF = start immediately with default values MAN = manual start with START key AUTO = start automatically (test with low current)
CONF:PW:MODE?	queries currently set starting mode
CONF:PW:DEF	sets all parameters for protective wire test to their default values: 5.0 s, 10 A, OFF

##### Insulation test

CONF:IT:TIME<test time>	sets test time: range 0.1 – 99.9; default 5.0 [s]
CONF:IT:TIME?	queries currently set test time
CONF:IT:RES:5M 50M	sets resistance range at 5M $\Omega$ or 50 M $\Omega$ resp., default 5 M $\Omega$
CONF:IT:RES?	queries currently set resistance range
CONF:IT:CON:SOCK PROB	selects how to connect DUT: SOCK = socket ( start immediately), default value PROB = test probe (start with START key)
CONF:IT:CON?	queries current connection of tested device
CONF:IT:DEF	sets all parameters for insulation test on their default values: 5 s, 5M, SOCK



### High voltage test DC

CONF:HD:TIME<test time>	sets test time: range 0.1 – 99.9; default 5.0 [s]
CONF:HD:TIME?	queries currently set test time
CONF:HD:CON:SOCK PROB	selects how to connect DUT: SOCK = socket ( start immediately), default value PROB = test probe (start with START key)
CONF:HD:CON?	queries current connection of tested device
CONF:HD:DEF	sets all parameters for DC-high voltage test at their default values: 5 s, SOCK

### High voltage test AC

CONF:HA:TIME<test time>	sets test time: range 0.1 – 99.9; default 5.0 [s]
CONF:HA:TIME?	queries currently set test time
CONF:HA:RAMP<ramp time>	Sets the time of starting ramp: range 0.0 - 60.0, default 1.0 [s]. There is not any ending ramp. This command is available only in device KT 3301E/g or in devices KT 3301E/d,e,f with an extension containing a programmable source.
CONF:HA:RAMP?	queries the actual value of ramp time.
CONF:HA:VOLT<nominal voltage>	Sets the nominal voltage of measurement. Range: 200 - 2500, default 2000 [V] - device KT3301E/d 200 - 5000, default 2000 [V] - device KT3301E/e,f 250 - 6000, default 2000 [V] - device KT3301E/g
CONF:HA:VOLT?	queries the actual value of nominal voltage.
CONF:HA:UTYP:AC DC	Sets the voltage type. Possible values are: AC - device KT 3301E/d,e AC DC, default AC - device KT 3301E/f DC - default for device KT 3301E/g
CONF:HA:UTYP?	queries the actual value of voltage type.
CONF:HA:IMAX<maximum current>	Sets the maximal current: range 0.0 - 99.9, default 4.0 [mA].(device KT3301E/d,e,f) range 0.0 - 9.99, default 4.0 [mA].(device KT3301E/g)
CONF:HA:IMAX?	queries the actual value of maximal current.
CONF:HA:START:MAN OFF	Sets the start mode: MAN - start test manually (button, 2-hand-control, test hood), default value OFF - start test immediately
CONF:HA:START?	queries the actual value of start mode.
CONF:HA:DEF	sets all parameters for AC-high voltage test at their default values: 5 s, SOCK

### Function test

CONF:FT:TIME<test time>	sets test time: range 0.1 – 99.9; default 5.0 [s]
CONF:FT:TIME?	queries currently set test time
CONF:FT:VOLT <nominal voltage>	Sets the nominal voltage of measurement: range 010 – 270, default 230 [V] <i>(Only with an extension containing a programmable source, otherwise it is fixed 230 V.)</i>
CONF:FT:VOLT?	Asks for the actual value of nominal voltage. <i>(Only with an extension containing a programmable source.)</i>
CONF:FT:UMOD:INT EXT	Sets the mode how the measuring voltage is attached: INT - internal (fixed 230 V) EXT - external (from 10 to 400 V)
CONF:FT:UMOD?	Asks for the actual voltage mode (internal/external).
CONF:FT:DEF	sets test time at their default value: 5 s

### ● **MEAS group**

MEAS:CT	starts continuity test
MEAS:PW	starts protective wire test
MEAS:IT	starts insulation test
MEAS:HD	starts high voltage test DC
MEAS:HA	starts high voltage test AC
MEAS:FT	starts function test
MEAS?	queries currently set test method

### ● **READ group**

#### Continuity test

READ:CT:CURR?	expects value for current, result is in [mA]
---------------	--

#### Protective wire test

READ:PW:CURR?	expects value for test current, result is in [A]
READ:PW:VOLT?	expects value for voltage drop (voltage related to current 10 A) result is in [V]
READ:PW:RES?	expects resistance value. result is in [mΩ]

#### Insulation test

READ:IT:CURR?	expects value for current, result in [μA]
READ:IT:VOLT?	expects value for voltage, result [V]
READ:IT:RES?	expects resistance value, result in [MΩ]

#### High voltage test DC

READ:HD:VOLT?	expects value for voltage, result in [kV]
READ:HD:CURR?	expects value for current, result in [mA]

#### High voltage test AC

READ:HA:VOLT?	expects value for voltage, result in [kV]
READ:HA:CURR?	expects value for current, result in [mA]

#### Function test

READ:FT:CURR?	expects value for current, result in [A]
---------------	--

#### ● **SYST group**

SYST:HALT	interrupts testing
SYST:PASS:ON OFF	green signal light is switched on or off
SYST:FAIL:ON OFF	red signal light is switched on or off
SYST:BEEP:SOFT LOUD	buzzer is switched on to either soft or loud volume for 100 ms

### 3.4.4 Status and error parameters

- **Command version** (controlling variant)

Device constant including which commands are supported by tester.

The one hundred (in future also the one thousand) digit positions characterizes the basic model, the other two positions are planned for variants. The value list will be updated when a new variant is being executed.

This value can be read by the command `*VER?`.

<i>C. version</i>	<i>Device name</i>	<i>Description</i>
710	KT 3301E/d	basic model: HV-test 200-2500V, only AC
711	KT 3301E/e	HV-test 200-5000V, only AC
712	KT 3301E/f	HV-test 200-5000V, AC or DC*
713	KT 3301E/g	HV-test 250-6000V, only DC*

- **Device mode** (device type)

Characterizes the current operating mode of tester. The value is in range 0-255 (unsigned shortint type in C-language)

This value can be read by the command `*MOD?`.

Bit position	B7	B6	B5	B4	B3	B2	B1	B0
Meaning	operating mode			data exchange		remote status		
Operating mode	manual			automatic		digital		
Bits B7 – B6 – B5	000 (0)			001 (32)		010 (64)		
Data exchange	RS-232			IEEE-488				
Bits B4 – B3	00 (0)			01 (8)				
remote status	testing			program exchange		result exchange		
Bits B2 – B1 – B0	000 (0)			001 (1)		010 (2)		

Data exchange and remote status are only relevant in operating mode »automatic«



- **Status register**

Characterizes the current activity when the device performs a testing.

This value can be read by the command `*STA?`.

Bit position	B7	B6	B5	B4	B3	B2	B1	B0
Meaning	<u>activity</u>				<u>test end</u>			

Status	hex	bin	dec
<b><u>Activity</u></b>			
idle state	\$00	0000 0000	0
test starting	\$10	0001 0000	16
test preparing	\$20	0010 0000	32
rampe up *	\$30	0011 0000	48
measuring	\$60	0110 0000	96
rampe down *	\$50	0101 0000	80
test ending	\$40	0100 0000	64
test finished	\$80	1000 0000	128
<b><u>Test end</u></b>			
STOP button	\$81	1000 0001	129
HA-test – high current	\$82	1000 0010	130
PW-test – start timeout	\$83	1000 0011	131
PW-test – disconnected	\$84	1000 0100	132
2-hand-control released	\$85	1000 0101	133
after SYST:HALT	\$8F	1000 1111	143
<i>* only when supported by device variant</i>			

**... STATUS AND ERROR PARAMETERS****Error messages**

They describe errors in command syntax or of their wrong use as well as device depending errors. The value is in range 0-255 (unsigned shortint type in C-language).

Number	Description
200	Queue overflow
0	No error
1	Invalid start character
2	Invalid end character
3	Invalid command
4	Invalid MEAS parameter
5	Invalid CONF parameter
6	Invalid SYST parameter
7	Invalid READ parameter
8	
9	Unable to start measurement

## 3.5 Error display

### 3.5.1 Error display

Most errors are displayed on the LCD (see below).  
Furthermore the red light *fail* signals the error if

- operator aborted or if
- there was an error during the test

### 3.5.2 Error messages on LC display

Error messages are not displayed in plain text on the LCD.  
Exceptions:

- time exceeded!  
if DUT was not contacted during PE test for more than 5 seconds
- ## NN-test FAIL  
if DUT failed current (##) test during PE, IS, or HV test (NN)
  - ☞ repeat with F2 (< REPEAT >) or key START
  - ☞ accept with F1 (< END >) and continue

You will find error/failure causes in the printer protocol (page or endless)  
(pl. see appendix, page 58).

## 3.6 Maintenance and function check

### 3.6.1 Maintenance

The test device *KT 3301E* needs no serving.



**Pull plug before opening housing!**

*SPS electronic GmbH* recommends to return series 3300 devices **for an annual check** to guarantee the accuracy of calibration/measured values.

Should defects be detected when checking those testers, then the device in question has to be recalibrated by *SPS electronic GmbH*.

### 3.6.2 Function check

#### Dummy test

To check functions of the testers or if you suspect some irregular function you should execute a dummy test regularly:

To do so execute with the tester protective wire, insulation or high voltage tests respectively at one or several DUTs – DUTs which will positively not pass these tests or for which different measurement results have already been established.

Please compare the results of both measurements afterwards.

Should the results be about the same then the tester functions perfectly, without errors.

## Appendix

### A Special functions

#### A-1 Program 00 (only in operating mode manual)



```

please go with key
START to PE-TEST

<END>   <CONTINUE>
    
```

If the number of tests to be executed is unknown, then the test can, in the current test mode, be repeated with program 00 until you

- end with option <END>
- or*
- select another test mode with option <CONTINUE>.

To select the cross section of line for PE test according EN 60 204, the cursor keys or external inputs can be used.

#### A-2 Digital program selection

In system parameter the operating mode *digitally* can be selected (pl. see 3.2.2). In this operating mode the test program is preselected via the digital interface *ext. IO* (Dsub25) at the back by coding the inputs 0 bis 3 binarily:

Pin-no. at Dsub25	14	13	12	11	<i>(pl. see next page)</i>
associated input	3	2	1	0	

	coding				corresponding to test program no.
<i>1 means: there is voltage of 24 V*</i>  <i>0 means: there is no voltage 24 V*</i>	0	0	0	0	0
	0	0	0	1	1
	0	0	1	0	2
	0	0	1	1	3
	0	1	0	0	4
	⋮				⋮
	1	1	1	1	15

\*24 V : unfiltered voltage (please see PIN configuration ext. IO-interface)

### A-3 Multistart tests

Often it can be useful to process several test programs one after another automatically.

Conceivable uses would be e.g. to let a DUT be tested with different voltage levels or to test different wirings over a test hood.

For this purpose the function "multistart" has been integrated in the compact tester **KT 3301E**.

To activate the multistart function:

1. in the parameter group *system parameter / special menu*, set the parameter *multistart* to YES
2. in the parameter group *test parameter / multistart*, select the desired value

Multistart works as follows:

- After switching on the device, at first the last runned test program will be performed.
- After finishing this program, the next program in the device's memory (program number + 1) will be run ...
- etc. ...

This means, if in the last session the program no.  $n$  was active, then

- Multistart 1 will run only program number  $n$
- Multistart 4 will run the programs  $n$  to  $n+3$  one after another
- Multistart 2 and 3 accordingly



According to the chosen multistart program the corresponding output of the external I/O-interface will be set automatically.

In order to successfully use the multistart-functionality, the following conditions must be met:

1. System parameter **operating mode = manual** (not automatik, not digital)
2. "n" must be "1" or greater. I.e. the last active program must not have been "program 0".

## B External Voltage Feed-In

In order to perform function tests with an externally fed-in voltage, one has to change the position of three jumpers in the device.



**Attention: Before opening the device, pull plug!**

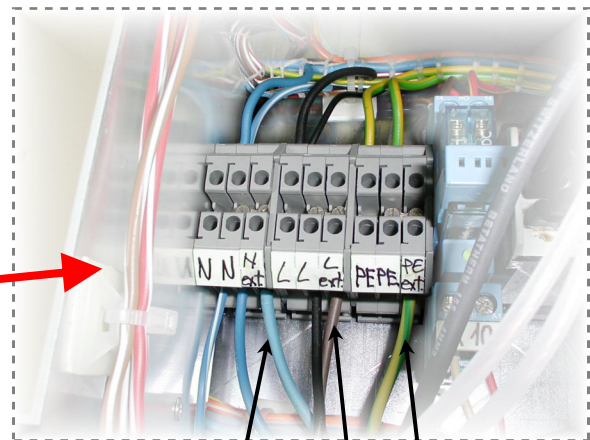
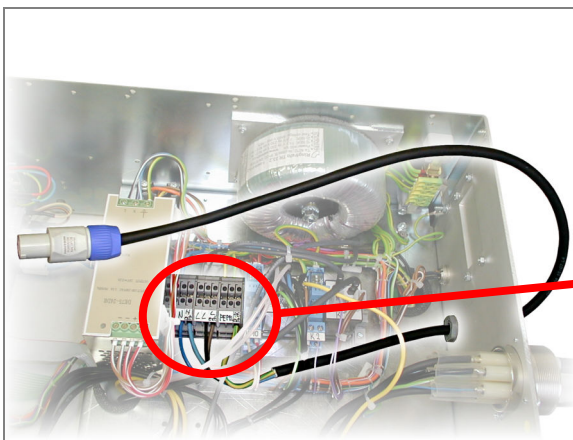

from external feed-in: **N L PE**

In default configuration, these three jumpers are located in "middle/left" position (N/N, L/L, PE/PE).

To switch the function test from internally generated to externally fed in voltage, one has to:

- connect the three lines N, L and PE of the feed-in cable to the terminals N<sub>ext</sub>, L<sub>ext</sub> and PE<sub>ext</sub> of the terminal block (see upper right picture)
- relocate the three jumpers to „middle/right“ position (N/N<sub>ext</sub>, L/L<sub>ext</sub>, PE/PE<sub>ext</sub>) :

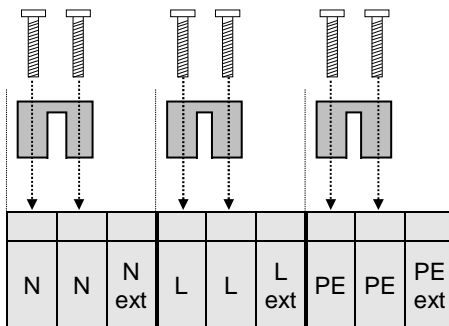

**FKT test with internal voltage**

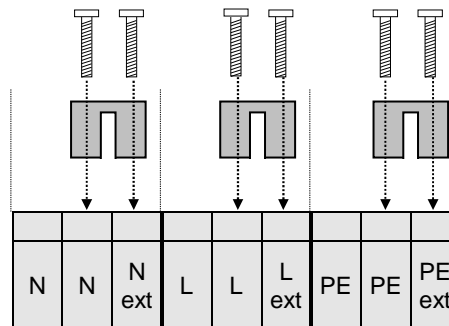

**FKT test with external voltage**

## C Interface Configuration

### C-1 PIN configuration for external IO-interface

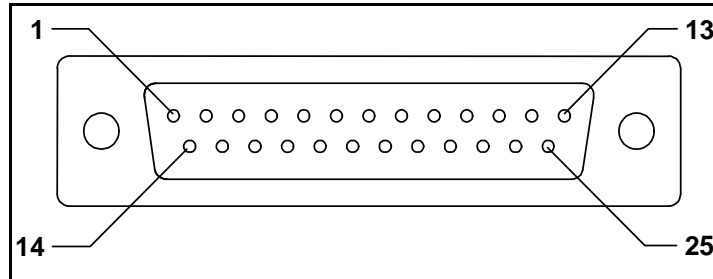

plug ext. I/O (Dsub25)

<i><b>PIN</b></i>	<i><b>description</b></i>	<i><b>configuration</b></i>
1	output 1-	EXT_PASS
2	output 2-	EXT_ERROR
3	output 3-	EXT_BUZZER
4	output 4-	EXT_TEST (active during complete test)
5	output 5-	
6	output 6-	
7	output 7-	
8	output 8-	
9		not used
10		not used
11	input 1	1 sqmm cross section selection / 4 bit-program selection
12	input 2	1,5 sqmm cross section selection / 4 bit-program selection
13	input 3	2,5 sqmm cross section selection / 4 bit-program selection
14	input 4	4,5 sqmm cross section selection / 4 bit-program selection
15	input 5	6 sqmm cross section selection
16	input 6	EXT_ACK
17	input 7	EXT_SWITCH
18	input 8	EXT_START
19	SK	Safety circuit HV-relay (+24 VDC)
20	+24 V DC	voltage against mass *)
21	+24 V DC	voltage against mass *)
22		not used
23	ON	external ON, +24 V DC
24	GNS	mass
25	GNS	mass

\*) internally generated voltage (**do not** feed in voltage from externally)



**Description of most important signals of I/O interface:**Inputs:

- 1 EXT\_ACK (input 6)
  - interrupts running tests
  - accepts a faulty measurement
  
- 2 EXT\_SWITCH (input 7)
  - to be applied for switching between the cross sections for PE test according EN 60 335 for program 00.
  
- 3 EXT\_START (input 8)
  - starts the test
  - repeats a faulty measurement
  - during HV-AC test always applied

Outputs:

- 1 EXT\_PASS (output 1)
  - setting same as *pass*-light
  
- 2 EXT\_ERROR (output 2)
  - setting same as *fail*-light
  
- 3 EXT\_BUZZER (output 3)
  - setting same as built-in buffer
  
- 4 EXT\_TEST
  - to be set after first start signal and stays active during entire test

## C-2 PIN configuration for serial printers and remote interface COM1

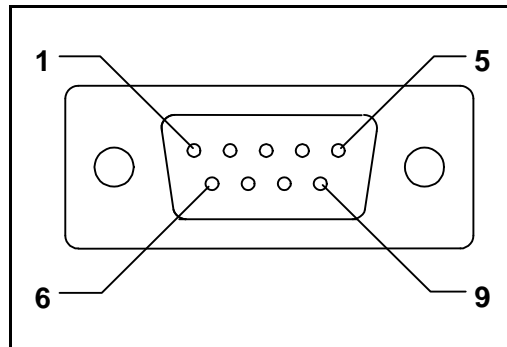

plug RS232 (Dsub9)

<i><b>PIN</b></i>	<i><b>Bezeichnung</b></i>	<i><b>Belegung</b></i>
1	-	not used
2	RxD	receive data
3	TxD	transmit data
4	-	not used
5	mass	reference potential of serial interface
6	-	not used
7	-	not used
8	-	not used
9	-	not used

**Interface setting:** 9600 baud, 8 data, 1 stopbit, no parity

**C-3 Socket for EMERGENCY STOP loop**

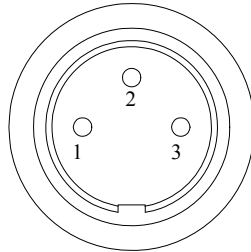

**Phono socket 3 pole (emergency stop)**

Only if PINs 1 and 2 are short-circuited the function voltage is put through to the socket.  
No configuration for PIN 3.

**C-4 Connection socket for warning lights X1**

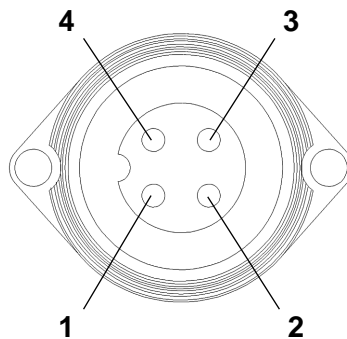

<b>PIN</b>	<b>Configuration</b>
<b>1</b>	N
<b>2</b>	red (230 V)
<b>3</b>	green (230 V)
<b>4</b>	PE

The connected warning lights must not exceed 25 Watts of total power.

### C-5 High voltage socket (X7) (only for system extension)

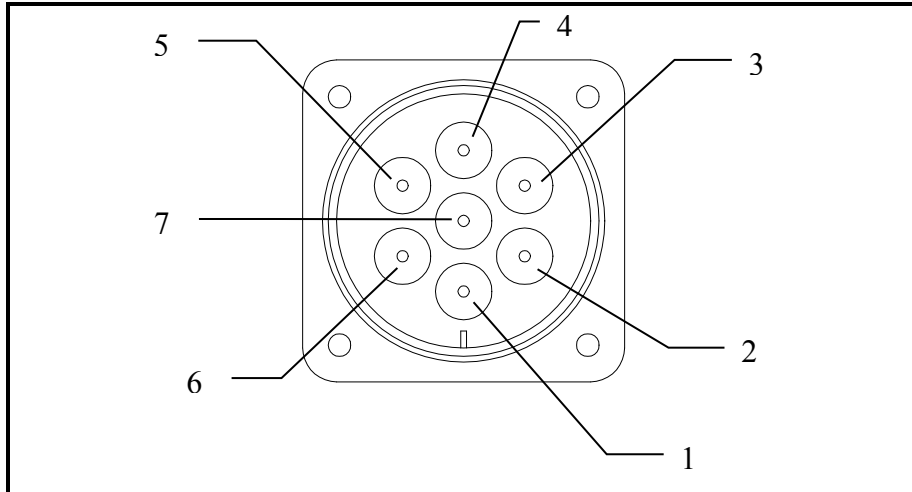

**High voltage socket X7 DUT (7-pole )**

<b>PIN</b>	<b>Description</b>	<b>Configuration</b>
<b>1</b>	HV+	connection for measuring line HVAC
<b>2</b>	l	phase (    to socket)
<b>3</b>	pe (HV-)	connection for PE of DUT
<b>4</b>	n	neutral wire (    to socket)
<b>5</b>	pe'	connection for sensor of ground wire (PE-test)
<b>6</b>	probe	connection for the measuring line (PE-,IS-,HVDC-test) (    to test probe)
<b>7</b>	probe'	connection for sensor of measuring line (PE-Test) (    to test probe)

## D Information on programming and program run

### D-1 Order of tests in manual or digital mode:

- DG - test
- PE - test
- IS - test
- HV-DC - test
- HV-AC - test
- FT - test

### D-2 Miscellaneous

- Protocol print-outs and issuing of audible signals take time after each test step. If protocols and audible signals are not needed, please adjust system parameters:

```

PROTOCOL → never
BUZZER   → off
  
```

- For digital control a bad result can also be accepted with EXT\_ACK. With new start signal the last step is repeated.
- If no min. current (approx. 0.6 A) is flowing after start of **PE-Test** (DUT not contacted or faulty) the current ramp is not built up. If the set current is not reached within 5 sec the error message »time exceeded« is displayed.

During **auto start** test is initiated if a min current (approx. 0.6 A) flows and ends if DUT is not contacted anymore. The waiting state is cancelled by pressing F1.

- The lights *pass* and *fail* appear after each test step and display always the partial results. The lights go out if a new test step is performed.

## E Protocolling of test results

 Only in output formats `page` and `endless` will the cause of error be printed in the protocol. The meanings are:

for all types of test	
U.BREAK	test was aborted by operator

for CT-test	
<I <sub>min</sub>	falling below min. value for current
>I <sub>max</sub>	max. value for current exceeded

for PE-test	
time	time exceeded (DUT was not contacted within five seconds)
<I <sub>soll</sub>	falling below nominal value for current
<R <sub>min</sub>	resistance smaller than R <sub>min</sub>
>R <sub>max</sub>	resistance larger than R <sub>max</sub>
>U <sub>zul</sub>	tolerance of voltage drop for selected cross section of a line was exceeded

for IS-test	
<R <sub>min</sub>	resistance smaller than R <sub>min</sub>
<U <sub>soll</sub>	falling below nominal value for test voltage
U <sub>sense</sub>	voltage measuring faulty

for HV-DC test	
>I <sub>max</sub>	max. value for current exceeded
<U <sub>soll</sub>	falling below nominal value for test voltage
U <sub>sense</sub>	voltage measuring faulty

for FT-test	
<I <sub>min</sub>	falling below min. value for current
>I <sub>max</sub>	max. value for current exceeded
START	start condition missing (for test with adapter)

**Example for protocol format »page«**

```

SPS electronic GmbH
SN: 123
program : 00      NONAME      date : 01.04.1998
-----
* PE-test parameters * t= 05.0 s   I = 10 AAC   Umax= 12 VAC
                    test accord. to EN 60335
                    Rmin= 100 mOhm   Rmax = 200 mOhm
                    time      | current | resist. | error   | result
                    -----
01: 12:30      | 00.0 AAC | 999 mOhm | time    | FAIL
02: 12:30      | 13.8 AAC | 140 mOhm | ----   | PASS
03: 12:31      | 01.2 AAC | 232 mOhm | <Inom  | FAIL
04: 12:31      | 01.0 AAC | 20 mOhm  | <Inom  | FAIL
* IS-test parameters * t= 05.0 s   U= 500 VDC   Rmin= 01.00 MOhm
                    time      | resist. | error   | result
                    -----
01: 12:32      |         | 00.2 MOhm | <Rmin  | FAIL
02: 12:32      |         | 07.6 MOhm | ----   | PASS
* HVDC-testparameters* t= 05.0 s   U= 1500 VDC   Imax= 1.0 mA
                    time      | current | voltage | error   | result
                    -----
01: 12:33      | 0.12 mA | 1.49 kV  | ----   | PASS
02: 12:33      | 0.00 mA | 1.49 kV  | ----   | PASS
* FT-test parameters *
01: t= 05.0 s tg= 01.0 s Imin= 00.0 AAC Imax= 00.5 AAC
02: t= 05.0 s tg= 01.0 s Imin= 00.0 AAC Imax= 01.0 AAC
                    time      | current | error   | result
                    -----
01: 12:33      | 00.2 mA |         | ----   | PASS
02: 12:34      | 00.6 mA |         | ----   | PASS
                    -----
                                total:          FAIL
    
```

**Example for protocol format »condensed«**

```

SPS electronic GmbH
Programm :01   END-Test           01.04.1998
-----
* PE-test parameters  t= 05.0 s
I =10 AAC   Umax =12 VAC
test accord. to EN 60335
Rmin= 080 mOhm   Rmax= 200 mOhm
   time | current | resist. | result
-----
01: 12:02 | 00.0 AAC| 999 mOhm| FAIL
01: 12:02 | 01.2 AAC| 228 mOhm| FAIL
01: 12:02 | 13.7 AAC| 138 mOhm| PASS
02: 12:03 | 13.5 AAC| 152 mOhm| PASS

* IS-test parameters  t= 05.0 s
U= 500 VDC Rmin= 05.00 MOhm
   time |          | resist. | result
-----
St: 12:04 |          |50.0 MOhm| PASS
01: 12:04 |          |07.6 Mohm| PASS

* HVDC-test parameters *  t= 05.0 s
U= 1500 VDC   Imax= 1.0 mA
   time | current | voltage | result
-----
St: 12:05 | 0.01 mA | 1.49 kV | PASS
01: 12:05 | 4.09 mA | 0.08 kV | FAIL
01: 12:06 | 0.15 mA | 1.49 kV | PASS
-----
12:06                total :      PASS

```

## F Handling of EEPROM Errors

Under very rare circumstances, it may happen that the data of test programs on the device's internal EEPROM gets damaged. Possible conditions are sudden power failure while the device is active, extreme voltage peaks caused by thunder stroke, and the like.

In this case, on the next power-on, the device will detect an EEPROM error during the power-on self test. To correct this error, the following steps have to be taken:

- An error message about the detected failure will be shown.
- After confirmation of the error message, the erroneous test program will be loaded.
- Now, this test program must be manually checked for unusual or plain silly values.
- If such are present, they must be set back to their original value, and be confirmed with <OK>

After having done so, the device should start up correctly again.

In case of more serious disorganisation of EEPROM data, there is the possibility to do a full EEPROM init:

- During empowering the device, press and hold the key <5>
- A dialog appears, wether to perform the EEPROM init (by <F2>), or to abort (by <F1>).
- When confirming with <F2>, the EEPROM will be fully set back to factory settings.

**ATTENTION:** Performing an EEPROM init will erase all test programs from device's memory!

## **G Terms of warranty**

### **1. Warranty period**

The warranty period is 12 months after delivery.

### **2. Conditions for a guarantee claim**

- The compact test device KT 3301E must have been put into operation by qualified personnel at the customer's.
- Inspections must be carried out regularly (once a year) and thoroughly (by SPS electronic GmbH).
- Defective or worn parts have to be replaced immediately. The operation of such parts is forbidden for safety reasons.
- Defective parts, subject to guarantee claims, have to be sent to SPS electronic GmbH for inspection.
- Defects occurred must be reported to SPS electronic GmbH immediately.

### **3. Beginning of guarantee period**

Guarantee starts with the date of delivery note.

### **4. Guarantee**

SPS electronic GmbH guarantees a good function of the high voltage test device, a conscientious and professional design and manufacture as well as the use of high-quality material.

All parts are being replaced free of charge if parts became defective or useless during the guarantee period due to the use of inadequate material, manufacturing faults or an imperfect engineering.

### **5. Excluded from guarantee**

- Damages due to outside influences, above all because of handling malpractices or of local conditions.
- Damages at devices from which the serial number has been removed, destroyed or falsified.
- Wear parts, such as fuses, signal bulbs, etc.

# EG-Konformitätserklärung

## EC Declaration of Conformity

---

Wir / we :

**SPS electronic GmbH**  
**Steuerungs- und Prüfsysteme**  
**Blätteräcker 18**  
**D-74523 Schwäbisch Hall**

erklären hiermit, dass das nachfolgend genannte Gerät den einschlägigen grundlegenden Sicherheitsforderungen der EG-Richtlinie entspricht.

*declare, that the following unit complies with all essential safety requirements of the EC Directive.*

Geräteart: Kompakttester  
Description of device: Compact Tester

Typ / Type : KT 3301 E

### EG Richtlinien / EC Directives:

- EG Maschinenrichtlinie 98/392/EWG mit Änderungen  
*EC Directive for machinery 98/392/EEC with amendments*
- EG Niederspannungsrichtlinie 2006/95/EC  
*EC Directive for low voltage 2006/95/EC*
- EG Richtlinie Elektromagnetische Verträglichkeit 2004/108/EC mit Änderungen  
*EC Directive electromagnetic compatibility 2004/108/EC with amendments*

Angewandte harmonisierte Normen:  
*Applicable harmonized standards:*

- EN 61 000-3-2; EN 61 000-3-3; EN 55 014-1; EN 55 014-2; EN 50 191

Angewandte nationale Normen und technische Spezifikationen:  
*Applicable national standards and technical specifications:*

19.12.2007

Datum / date:

**SPS** electronic  
**SPS electronic GmbH**  
Blätteräcker 18 • 74523 Schwäbisch Hall-Sulzdorf  
Telefon 0 79 07 / 878-0 • Fax 0 79 07 / 878-99

Unterschrift / Sign:

Dieser Konformitätserklärung unterliegt grundsätzlich nur das von uns gelieferte oder in Betrieb genommene Gerät. Für Änderungen und Erweiterungen ist der Betreiber verantwortlich und damit für die Sicherstellung der Übereinstimmung der veränderten Anlage mit der betreffenden EG-Richtlinie.

*Subject to this declaration of conformity is the device as supplied or placed into operation by us. The operator is responsible for subsequent alterations and extensions, and therefore has to ensure the altered unit complies with the corresponding EC directives.*